

Main technical data for an aqueous spray cleaning machine, for cleaning heights 900, 1200, 1500 and 1800 mm.

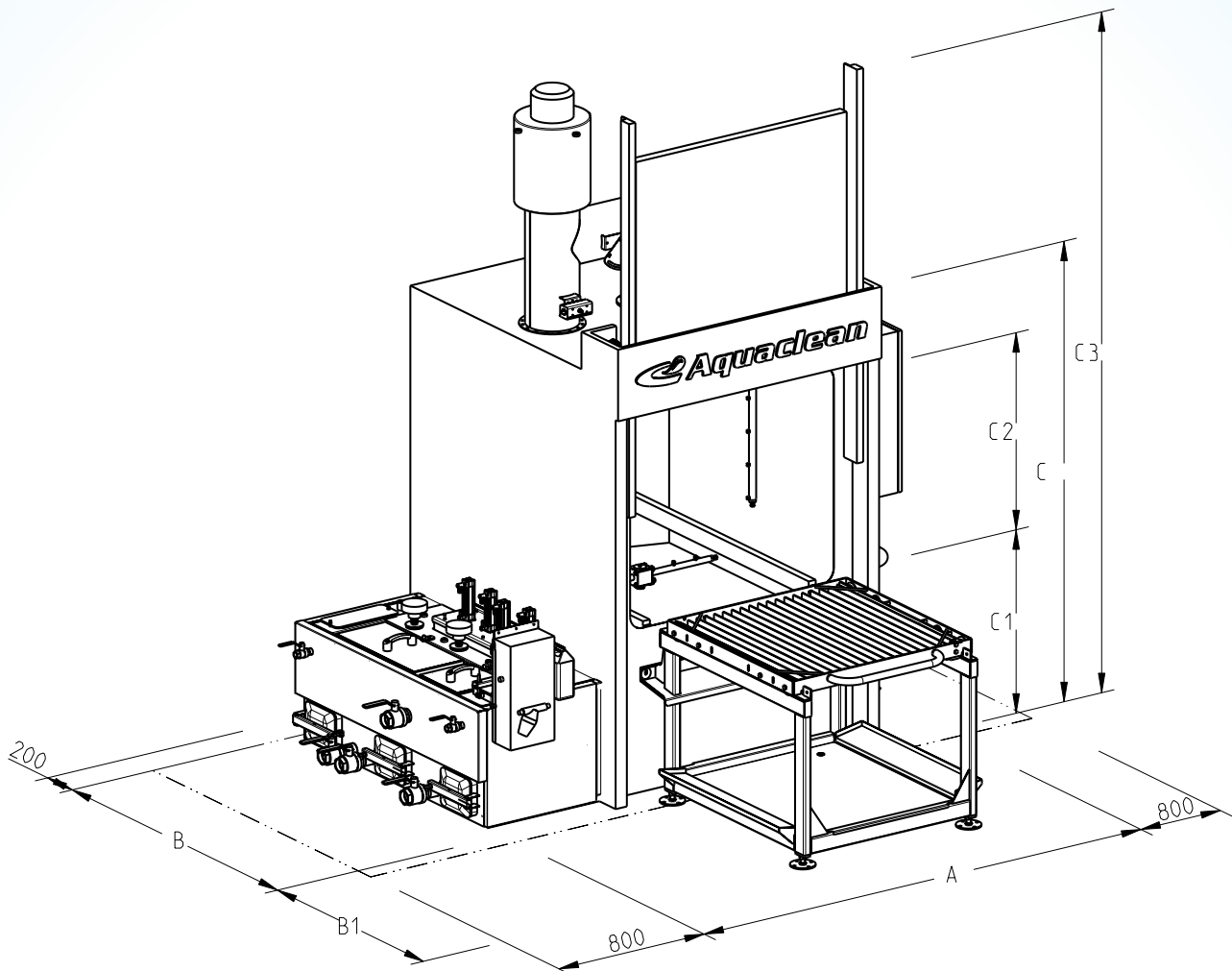

MAIN DIMENSIONS (mm)		AC-1.7-3LD (C2=900)	AC-1.7-C12-3LD (C2=1200)	AC-1.7-C15-3LD (C2=1500)	AC-1.7-C18-3LD (C2=1800)
Width	A	3350	3350	3350	3350
Depth	B	1990	1990	1990	1990
	B1	1470	1470	1470	1470
Height	C	2320	2720	3020	3320
	C1	910	910	910	910
	C2	900	1200	1500	1800
	C3	3390	3990	4590	5190
Load Carriage	L x W	1300	1300	1300	1300



TECHNICAL DATA		AC-1.7-3LD (C2=900)	AC-1.7-C12-3LD (C2=1200)	AC-1.7-C15-3LD (C2=1500)	AC-1.7-C18-3LD (C2=1800)
Tank volume l	Tank 1	650	650	650	650
	Tank 2	450	450	450	450
	Tank 3	400	400	400	400
Heating capacity kW	Tank 1	24	24	24	24
	Tank 2	12	12	12	12
	Tank 3	12	12	12	12
Pump flow l/min	Stage 1	450	490	540	590
	Stage 2	380	420	460	500
	Stage 3	380	420	460	500
Pump pressure bar	Stage 1	2.5	4.5	4.5	4.5
	Stage 2	2.5	2.5	3.0	3.0
	Stage 3	2.5	2.5	3.0	3.0
Pump motor kW	Stage 1	7.5	7.5	7.5	7.5
	Stage 2	3.0	3.0	4.0	4.0
	Stage 3	3.0	3.0	4.0	4.0
Max. component dimensions	L x W mm	1300	1300	1300	1300
	Height mm	900	1200	1500	1800
	Diam. mm	1500	1500	1500	1500
	Weight kg	800	800	800	800
Machine weight	kg	1800	1900	2000	2100
Connection power	kW	40	40	41	41